

2600 Series Explosion Proof Handlamp

Jobsite Lighting



Industry Leading Features:

- ⊕ cETLus listed
- ⊕ Class I & II Div 1 & 2, Groups C, D, F & G
- ⊕ NEMA 4X Rated, and Wet location rated
- ⊕ Copper-free, cast aluminum, anti-spark guard.
- ⊕ High-impact tempered borosilicate glass globe
- ⊕ Heat, chemical and impact resistant, glass reinforced handle
- ⊕ Cord restraint seal system provides flex and water resistance.
- ⊕ Accommodates #16/3 to #14/3 in various types of cord jackets.
- ⊕ Hand lamps are available in 25, 50 and 100 ft. cord lengths
- ⊕ -20°C to 40°C Ambient

 **Industry Leading, Ericson Exclusive**

Applications:

- Waste / Water treatment
- Grain elevators
- Mining
- Oil refineries
- Coal Barns/Fuel storage
- Hazardous locations
- Aerospace
- Shipyards



1926-12A-LED-L
Inline Low Voltage Transformer Version



Unique Features:



Heavy duty,
copper-free, cast
aluminum guard



Rubber bumper
protects case







Enclosed rated
LED Lamp



Non-conductive,
high-impact glass
reinforced handle

2600 Handlamp Series Selection Guide*:

Part Number	LED Wattage	Lumens	Cord Length / Cord Type	Bulb Type	Primary Connection	Low Voltage	LV Transformer
120VAC							
2600-LED	11 watts	1100	None, Hand Lamp Only	A19	None, Hand Lamp Only**	-	-
2625-LED	11 watts	1100	25 ft. / #14/3 SOOW	A19	1510-PW6P NEMA 5-15	-	-
2625-LED-XP	11 watts	1100	25 ft. / #14/3 SOOW	A19	Explosion Proof N5-15 Plug	-	-
2650-LED	11 watts	1100	50 ft. / #14/3 SOOW	A19	1510-PW6P NEMA 5-15	-	-
2650-LED-XP	11 watts	1100	50 ft. / #14/3 SOOW	A19	Explosion Proof N5-15 Plug	-	-
26100-LED	11 watts	1100	100 ft. / #14/3 SOOW	A19	1510-PW6P NEMA 5-15	-	-
26100-LED-XP	11 watts	1100	100 ft. / #14/3 SOOW	A19	Explosion Proof N5-15 Plug	-	-
12VAC, Low Voltage							
2600-LED-L	7.3 watts	850	None, Hand Lamp Only	A19	None, Hand Lamp Only***	Yes	1941-12-CF
2625-LED-L-CF	7.3 watts	850	25 ft. / #14/3 SOOW	A19	 1507-PW6P NON-NEMA	Yes	1941-12-CF
2650-LED-L-CF	7.3 watts	850	50 ft. / #14/3 SOOW	A19	 1507-PW6P NON-NEMA	Yes	1941-12-CF
26100-LED-L-CF	7.3 watts	850	100 ft. / #14/3 SOOW	A19	 1507-PW6P NON-NEMA	Yes	1941-12-CF
1926-12A-LED-L*	7.3 watts	850	25 ft. / #14/3 SOOW	A19	 NEMA 5-15	Yes	Inline 30VA
1926-12B-LED-L*	7.3 watts	850	50 ft. / #14/3 SOOW	A19	 NEMA 5-15	Yes	Inline 30VA

*1926 series is not listed.

** Assembled with 120-Volt, 11-Watt LED lamp only, no cord.

*** Assembled with 12-Volt, 7.3-Watt LED lamp only, no cord.

Low Voltage Transformers:

- Designed to meet NEC and OSHA Code Requirements for LV Lighting when used in Damp or Confined Space Applications.
- Transformers, in corrosion resistant, impact resistant non-metallic enclosures, convert 120vac to 12vac for areas where 12v is required.
- Available in Non-NEMA CF style receptacles for fixtures with dedicated 12vac lamps.
- Portable transformers are available with 4 receptacles providing 12vac power. Each Receptacle is individually overload protected.
- Portable Transformer is provided with industrial grade N5-15 plug.



Part Number	Transformer	Primary Cord Length	Primary Plug	Receptacle Configuration	Receptacle Overload Protection
1941-12CF	120V to 12V 400VA	6', 14/3 SOW Yellow	NEMA 5-15	 15A, NON-NEMA	4 ea, Push to Reset

2600 Series Replacement Parts:

Part Number	Replacement Part	Image Reference
2603	Handle	A
2604	Cord strain relief kit	B
2605	Replacement base & Socket assembly	C
2610	Guard & Globe Assembly	D
SLBLED-12	7.3 watt 12VAC LED Lamp	E
SLBLED-60	11 watt 120VAC LED Lamp	E



Product Specifications:

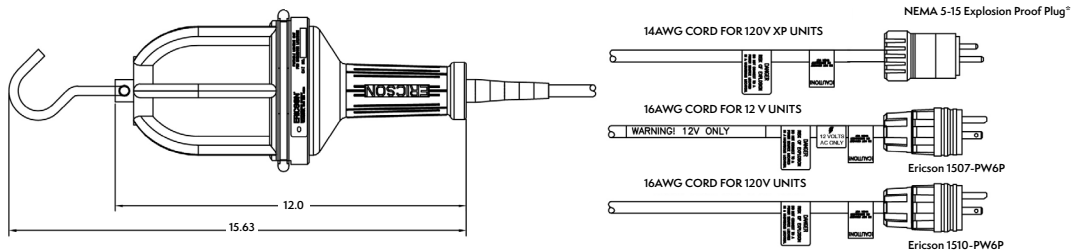

*Approved HAZ Location Manufacturers Plugs Available.

Related Products:



SL HAZ
Class I, Div II Stringlight



1009
Class I, Div II,
Highbay/Flood

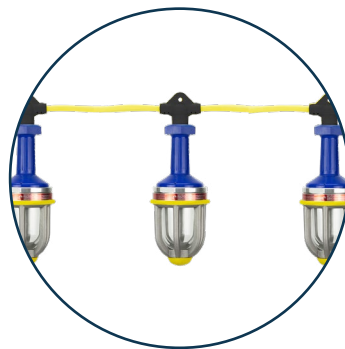

12310 Series
Class I, Div I
Hazardous Location Stringlight

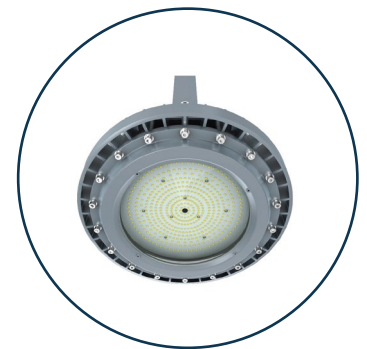

1007
Class I, Div I, Highbay



Ericson Manufacturing Company
4323 Hamann Parkway
Willoughby, OH 44094, USA



1-800-374-2766
info@ericson.com

L1000508E
Rev: 02/28/25